



# EHT



## Acoustic Kit

EHT Acoustic Air Inlet

OFFICIAL TEST REPORT



Test report available on demand.

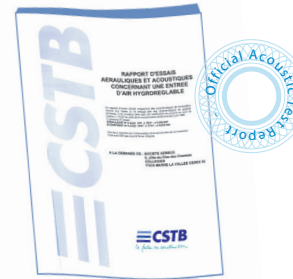

Dn,e,w (C;Ctr) Ø100mm :  
45 (0;-2) dB

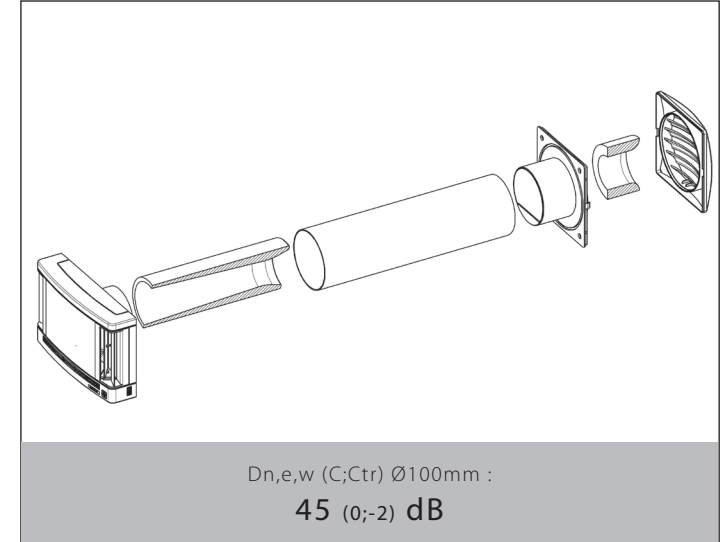
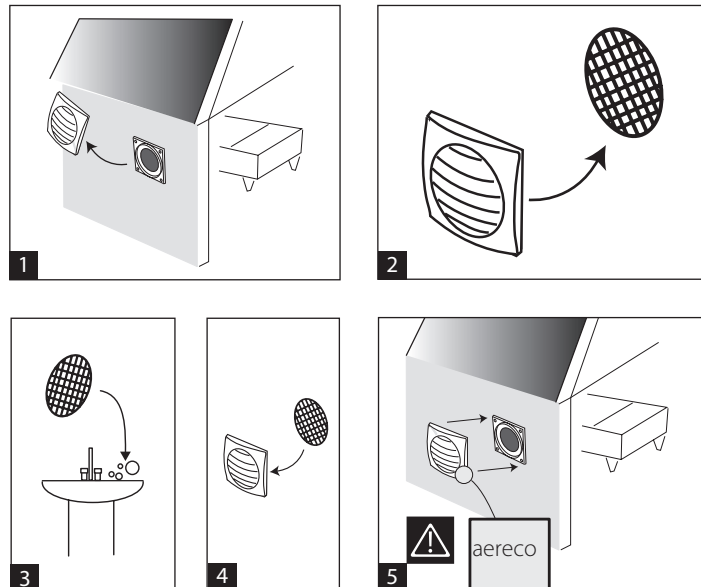
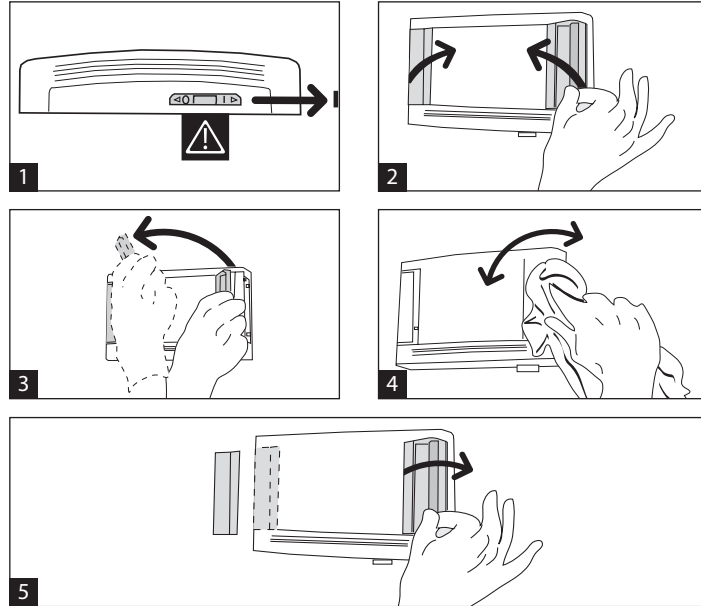

Dn,e,w (C;Ctr) Ø100mm :  
45 (0;-2) dB

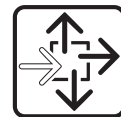
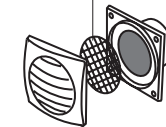
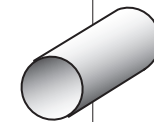
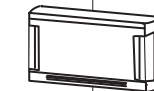

# aereco

9, allée du clos des charmes  
COLLEGIEN  
77 615 Marne la Vallée cédex 3  
FRANCE  
[www.aereco.com](http://www.aereco.com)



# aereco

